

Brass Hex Extension Elbows

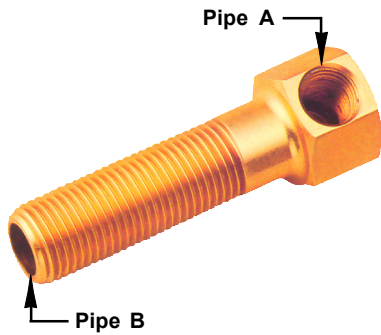

FEATURES:

- Positive Socket Wrench Installation
- 1-piece Construction Ensures Positive Alignment and Complete Removal
- Easy Length Adjustment with Adjustable Threads
- Custom Elbows are Available in Exact Lengths and a Wide Variety of Thread Combinations

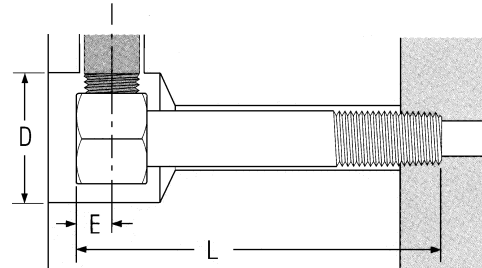

PART NO.	PIPE SIZE "A" (NPT)	PIPE SIZE "B" (NPT)	HEX SIZE	WRENCH CLEARANCE DIA. "D"	"E"	OVERALL LENGTH "L"							
						2½"	4"	5½"	7"	8½"	10"	11½"	13"
18B- *	1/8	1/8	3/4"	1¼"	9/32"	\$3.80	\$4.25	\$5.10	\$5.90	\$6.70	\$7.50	\$8.35	\$9.15
1814B- *	1/8	1/4	3/4"	1¼"	9/32"	\$4.25	\$5.05	\$6.35	\$7.45	\$8.55	\$9.60	\$10.70	\$11.75
14B- *	1/4	1/4	7/8"	1⅜"	11/32"	\$4.25	\$5.05	\$6.35	\$7.45	\$8.55	\$9.60	\$10.70	\$11.75
1438B- *	1/4	3/8	7/8"	1⅜"	11/32"	\$5.75	\$6.30	\$7.05	\$8.75	\$10.40	\$12.10	\$13.80	\$15.50
38B- *	3/8	3/8	1"	1½"	1/2"	\$5.75	\$6.30	\$7.05	\$8.75	\$10.40	\$12.10	\$13.80	\$15.60
50B- *	1/2	1/2	1¼"	1¾"	5/8"	\$8.35	\$9.15	\$12.15	\$15.00	\$17.85	\$20.70	\$23.50	\$26.35

*To order, insert desired overall length; Example: 14B-212

Hex Elbows

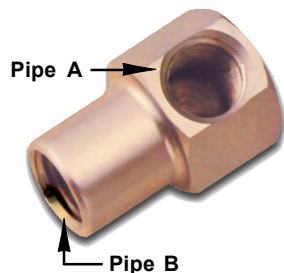

FEATURES:

- Available in Brass or Zinc-plated Steel
- Easy Socket Wrench Installation and Removal
- Angular Flow Path Allows Connecting Fittings to be Torqued Tight Without Choking Off Flow
- Requires Much Smaller Clearance Diameter Than Standard Pipe Elbows

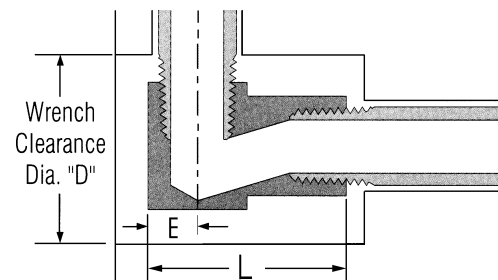

PIPE SIZE "A" (NPT)	PIPE SIZE "B" (NPT)	"L"	"E"	WRENCH CLEARANCE DIA. "D"	HEX SIZE	STEEL		BRASS	
						PART NO.	PRICE EACH	PART NO.	PRICE EACH
1/16	1/16	13/16"	7/32"	1"	9/16"	16S	\$2.85	16B	\$2.75
1/8	1/8	1"	9/32"	1¼"	3/4"	18S	\$2.60	18B	\$2.40
1/8	1/4	1¼"	9/32"	1¼"	3/4"	1814S	\$2.65	1814B	\$2.60
1/4	1/4	1⅜"	11/32"	1⅜"	7/8"	14S	\$2.75	14B	\$2.65
1/4	3/8	1⅜"	11/32"	1⅜"	7/8"	1438S	\$3.60	1438B	\$3.60
3/8	3/8	1⅝"	1/2"	1½"	1"	38S	\$3.65	38B	\$3.65
1/2	1/2	1⅞"	9/16"	1⅞"	1¼"	50S	\$5.60	50B	\$6.10
3/4	3/4	2¼"	5/8"	2¼"	1½"	75S	\$7.95	75B	\$8.95

Brass Hexkey Street Elbows

FEATURES:

- Extra Heavy Duty Hex Socket Allows Maximum Assembly Torque
- Hexkey Street Elbows Install With an Allen Wrench for Positive Assembly and Removal
- Angular Flow Path Allows Connecting Fittings to be Torqued Tight Without Choking Off Flow

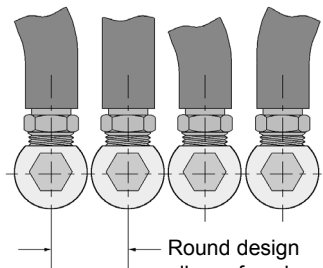
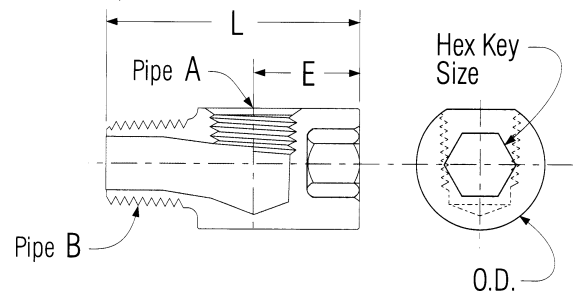

Round design allows for close connections.

PART NO.	PIPE SIZE "A" (NPT)	PIPE SIZE "B" (NPT)	"L"	"E"	O.D.	MIN. CLEARANCE DIA.	HEX KEY SIZE	PRICE EACH
KL16	1/16	1/16	1.156"	.531"	.552"	9/16"	1/4"	\$3.65
KL1618	1/16	1/8	1.218"	.531"	.615"	5/8"	5/16"	\$3.65
KL18	1/8	1/8	1.312"	.580"	.615"	5/8"	5/16"	\$3.05
KL1814	1/8	1/4	1.500"	.593"	.860"	7/8"	3/8"	\$3.00
KL14	1/4	1/4	1.625"	.660"	.860"	7/8"	3/8"	\$3.15
KL1438	1/4	3/8	1.625"	.712"	.985"	1"	1/2"	\$4.05
KL38	3/8	3/8	1.750"	.780"	.985"	1"	1/2"	\$4.95
KL50	1/2	1/2	2.250"	.940"	1.235"	1 1/4"	1/2"	\$7.80

Brass Hexkey Elbows

FEATURES:

- Hexkey Elbows Install With an Allen Wrench for Positive Assembly and Removal
- Compact, Round Design Allows for Close Connections
- Angular Coolant Path Prevents Fitting Interference at Assembly and Guarantees Full Flow

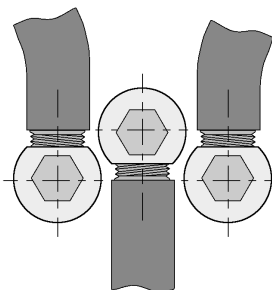
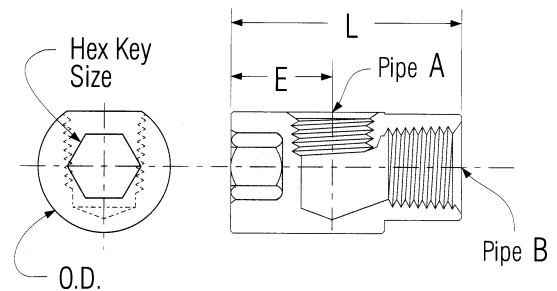
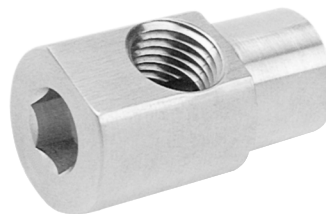

PART NO.	PIPE SIZE "A" (NPT)	PIPE SIZE "B" (NPT)	"L"	"E"	O.D.	MIN. CLEARANCE DIA.	HEX KEY SIZE	PRICE EACH
HKL16	1/16	1/16	1.125"	.531"	.552"	9/16"	1/4"	\$3.65
HKL18	1/8	1/8	1.250"	.580"	.615"	5/8"	5/16"	\$3.05
HKL1814	1/8	1/4	1.375"	.593"	.860"	7/8"	3/8"	\$3.15
HKL14	1/4	1/4	1.500"	.660"	.860"	7/8"	3/8"	\$3.15
HKL1438	1/4	3/8	1.625"	.712"	.985"	1"	1/2"	\$4.05
HKL38	3/8	3/8	1.750"	.780"	.985"	1"	1/2"	\$4.95
HKL50	1/2	1/2	2.125"	.940"	1.235"	1 1/4"	1/2"	\$7.80

Brass Hexkey Extension Elbows

FEATURES:

- Round Design Allows for Close Connections
- Extra Heavy Duty Hex Socket and 1-piece Construction Ensure Positive Assembly and Removal
- Hexkey Extension Elbows are Round and Install With an Allen Wrench — Wrench Clearance is Not Required, Making These Elbows Ideal for Use Inside the Mold or Anywhere Space is Limited
- Angular Flow Path Allows Connecting Pipe Fittings to be Torqued Tight Without Choking Off Flow
- Accurate Length Adjustments are Easy With the Patented Thread System
- Specifically Designed to Maintain High Flow Rates and Improve Cycle Times

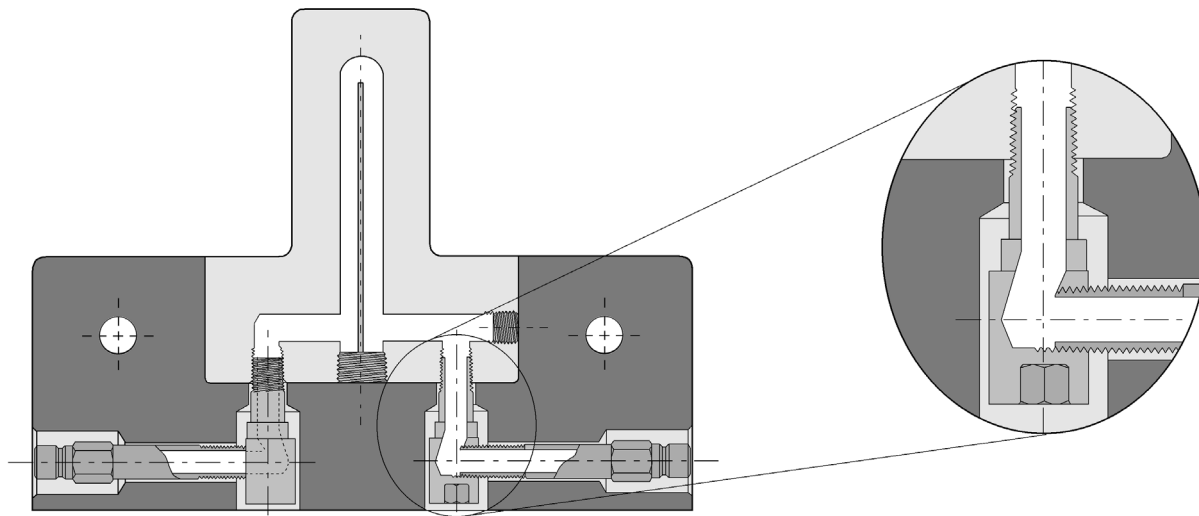
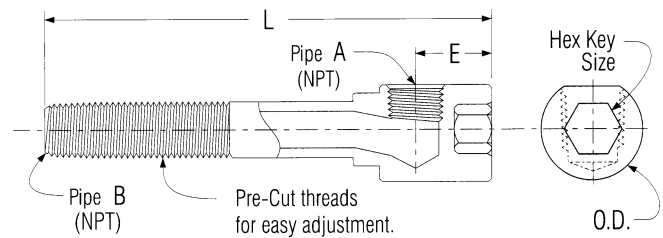

PART NO.	PIPE SIZE "A" (NPT)	PIPE SIZE "B" (NPT)	"E"	O.D.	MIN. CLEARANCE DIA.	HEX KEY SIZE	OVERALL LENGTH "L"							
							2½"	4"	5½"	7"	8½"	10"	11½"	13"
EKL16-*	1/16	1/16	.531"	.552"	9/16"	1/4"	\$5.40	\$5.85	\$6.50	\$8.00	\$8.35	\$8.80	\$9.05	\$9.35
EKL18-*	1/8	1/8	.580"	.615"	5/8"	5/16"	\$4.75	\$5.10	\$5.40	\$5.95	\$6.90	\$7.85	\$8.80	\$9.75
EKL14-*	1/4	1/4	.660"	.860"	7/8"	3/8"	\$5.10	\$5.55	\$6.05	\$6.90	\$8.35	\$9.75	\$11.15	\$12.60
EKL38-*	3/8	3/8	.780"	.985"	1"	1/2"	\$6.65	\$7.20	\$7.95	\$8.80	\$10.70	\$12.50	\$14.35	\$16.20
EKL50-*	1/2	1/2	.940"	1.235"	1¼"	1/2"	\$10.00	\$10.65	\$11.50	\$14.30	\$17.30	\$20.25	\$23.25	\$26.20

*To order, insert desired overall length; Example: EKL14-212

Brass Hexkey Extension Pipes

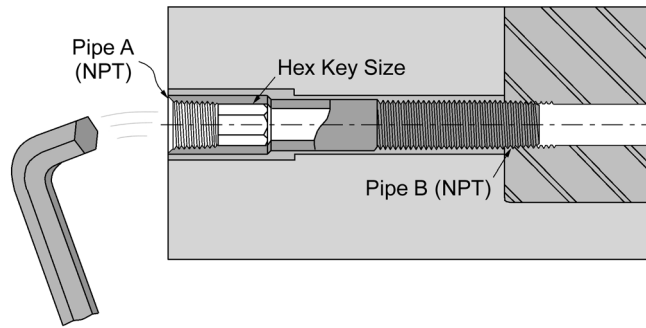
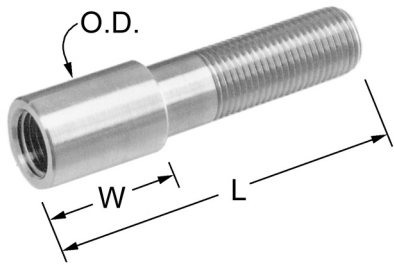

FEATURES:

- Heavy Duty Internal Hex Socket
- Hexkey Extension Pipes are Available in a Wide Variety of Special Lengths and Threads
- Accurate Length Adjustments are Easy With the Adjustable Thread System

PART NO.	PIPE SIZE "A" (NPT)	PIPE SIZE "B" (NPT)	"W"	O.D.	HEX KEY SIZE	OVERALL LENGTH "L"				
						2½"	4"	5½"	7"	8½"
EP18-__*	1/8	1/8	3/4"	1/2"	1/4"	\$3.05	\$3.60	\$4.90	\$5.70	\$6.50
EP14-__*	1/4	1/4	1"	11/16"	3/8"	\$3.40	\$3.95	\$5.20	\$6.00	\$6.85
EP38-__*	3/8	3/8	1¼"	13/16"	1/2"	\$3.80	\$4.45	\$6.15	\$8.00	\$9.05
EP50-__*	1/2	1/2	1½"	1"	9/16"	\$6.50	\$7.25	\$8.75	\$10.30	\$11.60

*To order, insert desired overall length; Example: EP14-212

Piston Tubes

FEATURES:

- *Stainless Steel Tubes*
- Precision Brazed Assembly Provides High Strength and Reliable Performance
- Coolant Flows Through Hex Socket and High Flow Stainless Tube
- High-Flow Stainless Tube Provides Maximum Cooling Rates

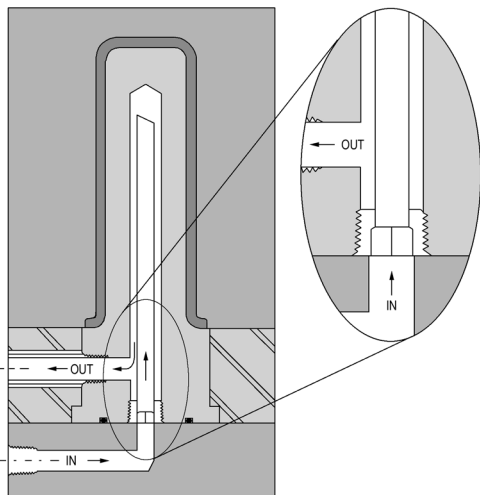
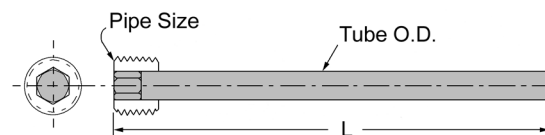
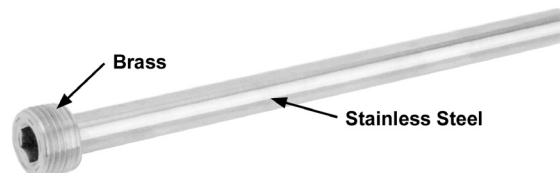

PART NO.	PIPE SIZE (NPT)	TUBE O.D.	TUBE I.D.	OVERALL LENGTH "L"			
				12"	24"	36"	48"
PT16-__B*	1/16	.125"	.109"	\$8.45	\$9.65	\$10.85	\$12.05
PT18-__B*	1/8	.187"	.167"	\$8.45	\$9.65	\$10.85	\$12.05
PT14-__B*	1/4	.250"	.230"	\$8.95	\$10.15	\$11.35	\$12.55
PT38-__B*	3/8	.375"	.345"	\$9.25	\$10.45	\$11.65	\$12.85
PT12-__B*	1/2	.375"	.345"	\$9.65	\$10.85	\$12.05	\$13.25
PT34-__B*	3/4	.437"	.407"	\$15.40	\$16.50	\$17.50	\$18.50

*To order, insert desired overall length; Example: PT14-24B

Pipe plug also available in steel or stainless steel.

Brass Adjustable Hex Nipples

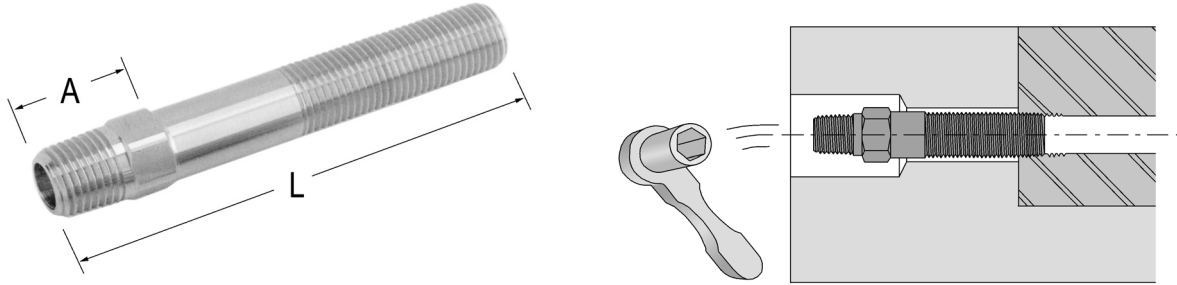

FEATURES:

- Adjustable Threads for Perfect Positioning
- Standard NPT Tapered Pipe Threads Both Ends
- Especially Useful When Installing Cascade Heads, Hex Elbows, etc. Inside Molds and Slides
- Longer or Special Exact Lengths Available
- Also Available in Special Thread Combinations

PART NO.	PIPE SIZE (NPT)	"A"	HEX SIZE	OVERALL LENGTH "L"							
				2½"	4"	5½"	7"	8½"	10"	11½"	13"
APN16-__*	1/16	11/16"	3/8	\$2.80	\$3.30	\$3.80	\$4.25	--	--	--	--
APN18-__*	1/8	3/4"	7/16	\$1.95	\$2.40	\$3.20	\$3.95	\$4.45	\$5.15	\$6.70	\$8.05
APN14-__*	1/4	7/8"	9/16	\$2.15	\$2.60	\$3.85	\$4.25	\$4.95	\$5.70	\$6.50	\$7.55
APN38-__*	3/8	1"	11/16	\$3.15	\$3.55	\$4.20	\$5.15	\$6.00	\$7.45	\$8.75	\$10.10
APN12-__*	1/2	1⅜"	7/8	\$4.20	\$4.85	\$5.95	\$7.30	\$8.70	\$10.40	\$11.75	\$13.30

*To order, insert desired overall length; Example: APN14- 212